



**Finally Racecar Bodies
that Look Like Real Cars**

The Muscle Cars Are Back!

THE ROCK

**Chase Elliott
Wins at The Rock**



**2011
Muscle Car Catalog**

Do All to the Glory of GOD 1st Cor. 10:31

GOD HAS SURELY BLESSED OUR COMPANY AND OUR CUSTOMERS!



Brent Downey
2010 Sunoco Series Champion



Brian Ortiz
2010 Sunoco Series
Rookie of the Year



Chase Elliott
Wins Rockingham
2010 Sunoco Series

GG
Photos

2011 Muscle Car Catalog Contents

2011 Camaro Body Panels & Parts 2
List of individual body components and accessories

2011 Camaro Body Packages 3
Complete body packages and time saving components

2011 Mustang Body Panels & Parts 4
List of individual body components and accessories

2011 Mustang Body Packages 5
Complete body packages and time saving components

Muscle Car Body Dimensin Sheet 6
All Heights, Widths and Measurments

Fender and Nose Braces 7
Steel, Aluminum and Flex Braces, Replaceable Ends

Bumper Bars, Pin Bars & Grill Screens 8
Bumper Bars, Hood and Tail Pin Bars, Lower Grill Screens

Bumper Bar Installation Kits & Sliders 9
Bumper installation kits and Adjustable Sliders

Valances, Valance Washers & Brake Ducts 10
Adjustable Wear Strips, Attachment Kits and Offset Brake Ducts

Hood Pin Kits, Replacement Clips & Brackets 11
Hood Pin Kits, Replacement Clips, Lanyards and Cowl Brkts

Body Mounting Adjustable Braces 12
Adjustable 3/8" Hex Body Brace Kits, Stainless Clamps

Create-a-Brace Kits 13
Prethreaded Ready to use Hex Tubes, Clamps and Brackets

AERO Enhancing Products 14
Roof Supports, Window Braces, Fender Supports

AERO Enhancing Products 15
AERO Bracing, Right Side Body Brace, Quarter/Tail Support

Cowl Air Induction Products 16
Cold Air Boxes, Air Filters, Adjustable Aluminum Turn Down

Garage & Pit Accessories 17
Duct Tape, Wire Ties, Tire Tapes & Air Filters

Rivets, Clecos, Washers & Drill Bits 18
Avex and Exploding Star Rivets, Backup Washers, Cleco Pliers

A Few of our Friends 19
Pictures of our Customers Muscle Cars

Composite LMSC Bodies 20

NGB Sportsman Bodies 21

Full Size Truck Reg & Ext Cab 22
List of individual body components and accessories

Full Size Truck Reg & Ext Cab 23
Pictures of Regular and Extended Cab Trucks

88 Monte Carlo 24
Noses, Grill Screens and Graphics

88 Monte Carlo 25
Valance Wear Strips, Rear Bumper Cover, Spoilers and Hood

86 Caprice 26
Noses, Grill Screens and Graphics

86 Caprice 27
Bumper Bars, Pin Bars, Spoiler Mount Kit, Spoilers and Hood

EZ-MAX Duct Work Systems 28
EZ-MAX Duct Work Systems for ABC, LMSC, NGB Sportsman

Ordering Information 29

EZ Access Doors 6" x 6" and 6" x 14"



Each kit includes: Door, Trim Ring, Hinge, Backing Plate (doubler), Dzus Button with nylon attachment washer, Spring and installation rivets. Great for access to Brake Pedals, Duct Work, Fuel Filler, Filters, Gauges, Shifters, etc...

Professional look... EZ to Install

6x6 - PN 50310-6X \$ 29.95
 6x14 - PN 50310-14X \$ 38.95

X at end of part number = color
 B=Black, CB=Chevron Blue,
 HP=Hoosier Purple,
 M=Mill Finish, O=Orange,
 PB=Pepsi Blue, R=Red,
 W=White, Y=Yellow

Molded Side Vent Windows

Molded Door Vent Windows, 1 left & 1 right



PN 72101 \$ 29.00 pr

Molded for Better Aerodynamics!

2011 Camaro Body Panels & Parts



2011 Camaro Individual Body Components

Change x to L (left) or x to R (right)

Body Panels Available in 7 Colors, Add color code to end of part number

Color Codes: W=White, B=Black, R=Red, Y=Yellow,
O=Orange, CB=Chevron Blue, PB=Paper Blue

Description	Camaro	Color	*Racer
Fender, composite	11000x	184.50	139.50
Door, aluminum	11010x	104.25	97.50
Quarter, composite	11020x	231.50	194.50
Rocker Panel, aluminum	20340	42.50	33.50
Roof, composite flange fit	11050	288.00	209.50
Hood, composite	11060	340.00	219.50
Deck Lid, aluminum	11070	77.75	69.50
Deck Filler, composite	11075	141.00	121.00
Cowl Kit	20380	238.00	208.50
Nose, per side, composite	11005x	149.50	119.50
Rear Bumper Cover, composite	11015x	123.50	98.50
Front Roof Support	20351		29.95
Rear Roof Support	20352		29.95
3 pc Front Window Brace Kit	701203		67.50
4 pc Rear Window Brace Kit	711110		87.00
Aero Deck Lid Hold Down	12276		14.95
Grill Screen	11091		46.50
Front Bumper Bar	11055		30.00
Rear Bumper Bar	11065		30.00
Hood Pin Bar	11058		19.50
Tail Pin Bar	11067		18.50
Muscle Car Front, precut	70203		318.00
Muscle Car Rear, oversize	71000		135.00
Quarter Windows, set L & R	72110		73.00
Lexan Spoiler Kit (6.5 x 60 x 65)	1106665		107.50
Master Graphics Kit	110420		56.95
Nose ID Graphics Kit	110421		37.95
Taillights	110415		26.00

* White Body Panels



2011 Camaro Body Packages

A-Package: (This package includes all of your basic body panels)
Flange Fit Composite Roof, Scooped Hood, Quarter Panels, Fenders, 2 pc Nose, 2 pc Rear Bumper Cover, Flange Fit Deck Filler with integrated lower window base and package tray area, Flange Fit Cowl Panel with integrated lower window base and dash starting edge, Removeable center hole for cowl panel with 2.5" x 20" cowl air induction hole, Aluminum Doors, Rockers and Deck Lid.

Part# 110010A-x **White** \$ 1995.00
 Color \$ 2345.00

**Painting your body can add up to 30lbs to its weight if you prime and seal it. Much of that added weight is up to 48" in the air which is not what you want on a race car. Our precolored bodies do not add any extra weight... A Great weight savings and its more economical than painting!*

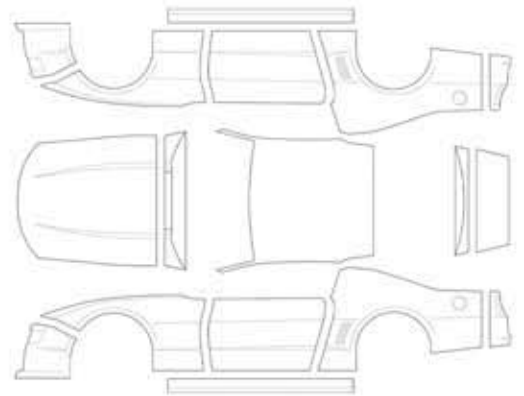

C-Package: (This package includes our A package plus Windows & Lexan Spoiler) This package includes Mar Resistang Molded precut Front Windshield, Molded Rear Window and Quarter Windows, Premium 4 pc Lexan Spoiler Kit that includes 2 pc Tig Welded Aluminum Spoiler Base & 2 pc Lexan Spoiler Blade.

Part# 110010C-x **White** \$ 2595.00
 Color \$ 2945.00

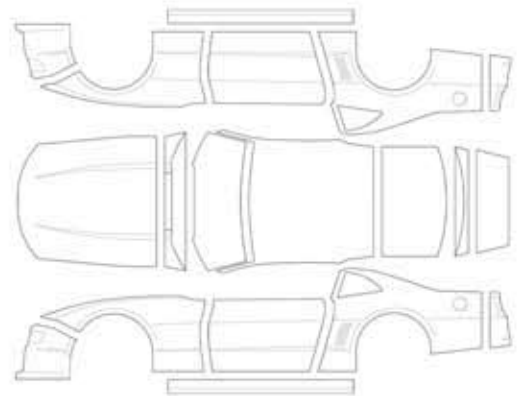

M-Package: (This package includes both A & C packages plus some of the commonly used accessories you will need to install your new body) This package includes prefomed full wrap Front Bumper Bar, preformed full wrap Rear Bumper Bars, Hood & Deck Pin bars with tabs, Lightweight Front Roof Support, Lightweight Rear Roof Support, 3 pc Black powder coated Trick Front Window Braces, 2 pc Black powder coated Trick Rear Window Braces, CNC manufactured Grill Screen with welded stainless screen and lightweight aluminum bezel, Extruded AERO aluminum Deck Lid Hold Down, 4 Billet Aluminum Spoiler Braces, Complete Master Graphics Kit with Headlights, Center Grill, Taillights and ID Kit, 11 pc Aluminum Hood Pin Kit, Valance wear strip in your choice of color, Valance Installation Kit, 1 pair Molded Vent Windows.

Part# 110010M-x **White** \$2995.00 **Color** \$3245.00



X at the end of part number represents body panel color
Color Codes: W=White, B=Black, R=Red, Y=Yellow, O=Orange, CB=Chevron Blue, PB=Pepsi Blue

2011 Mustang Body Panels & Parts



2011 Mustang Individual Body Components

Change x to L (left) or x to R (right)

Body Panels Available in 7 Colors, Add color code to end of part number

Color Codes: W=White, B=Black, R=Red, Y=Yellow,
O=Orange, CB=Chevron Blue, P=Paper Blue

Description	Mustang	Color	*Racer
Fender, composite	20300x	184.50	139.50
Door, aluminum	20310x	104.25	97.50
Quarter, composite	20320x	231.50	194.50
Rocker Panel, aluminum	20340	42.50	33.50
Roof, composite flange fit	20350	288.00	209.50
Hood, composite	20360	340.00	219.50
Deck Lid, aluminum	20370	77.75	69.50
Deck Filler, composite	20375	141.00	121.00
Cowl Kit	20380	238.00	208.50
Nose, per side, composite	20305x	149.50	119.50
Rear Bumper Cover, composite	20315x	123.50	98.50
Front Roof Support	20351		29.95
Rear Roof Support	20352		29.95
3 pc Front Window Brace Kit	701203		67.50
4 pc Rear Window Brace Kit	711203		87.00
Aero Deck Lid Hold Down	12276		14.95
Grill Screen	20391		46.50
Front Bumper Bar	20355		30.00
Rear Bumper Bar	20365		30.00
Hood Pin Bar	20358		19.50
Tail Pin Bar	20367		18.50
Muscle Car Front, precut	70203		318.00
Muscle Car Rear, precut	713203		135.00
Quarter Windows, set L & R	72203		73.00
Lexan Spoiler Kit (6.5 x 60 x 65)	2036665		107.50
Master Graphics Kit	203420		56.95
Nose ID Graphics Kit	203421		37.95
Taillights	203415		26.00

* White Body Panels



2011 Mustang Body Packages

A-Package: (This package includes all of your basic body panels)

Flange Fit Composite Roof, Scooped Hood, Quarter Panels, Fenders, 2 pc Nose, 2 pc Rear Bumper Cover, Flange Fit Deck Filler with integrated lower window base and package tray area, Flange Fit Cowl Panel with integrated lower window base and dash starting edge, Removeable center hole for cowl panel with 2.5" x 20" cowl air induction hole, Aluminum Doors, Rockers and Deck Lid.

Part# 203010A-x **White** **\$ 1995.00**
Color **\$ 2345.00**

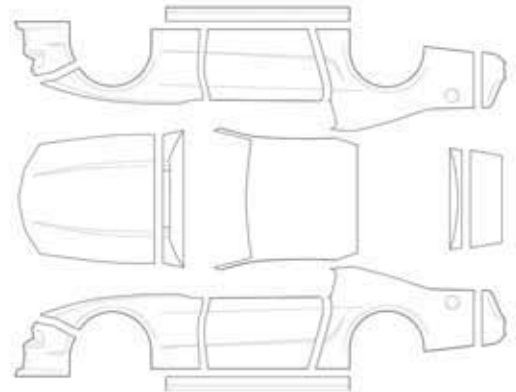

**Painting your body can add up to 30lbs to its weight if you prime and seal it. Much of that added weight is up to 48" in the air which is not what you want on a race car. Our precolored bodies do not add any extra weight... A Great weight savings and its more economical than painting!*

C-Package: (This package includes our A package plus Windows & Lexan Spoiler) This package includes Mar Resistang Molded precut Front Windshield, Molded Rear Window and Quarter Windows, Premium 4 pc Lexan Spoiler Kit that includes 2 pc Tig Welded Aluminum Spoiler Base & 2 pc Lexan Spoiler Blade.

Part# 203010C-x **White** **\$ 2595.00**
Color **\$ 2945.00**

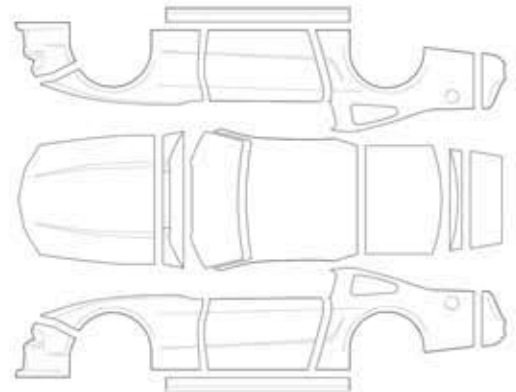

M-Package: (This package includes both A & C packages plus some of the commonly used accessories you will need to install your new body) This package includes preformed full wrap Front Bumper Bar, preformed full wrap Rear Bumper Bars, Hood & Deck Pin bars with tabs, Lightweight Front Roof Support, Lightweight Rear Roof Support, 3 pc Black powder coated Trick Front Window Braces, 2 pc Black powder coated Trick Rear Window Braces, CNC manufactured Grill Screen with welded stainless screen and lightweight aluminum bezel, Extruded AERO aluminum Deck Lid Hold Down, 4 Billet Aluminum Spoiler Braces, Complete Master Graphics Kit with Headlights, Center Grill, Taillights and ID Kit, 11 pc Aluminum Hood Pin Kit, Valance wear strip in your choice of color, Valance Installation Kit, 1 pair Molded Vent Windows.

Part# 203010M-x **White** **\$2995.00** **Color** **\$3245.00**



X at the end of part number represents body panel color
 Color Codes: W=White, B=Black, R=Red, Y=Yellow, O=Orange, CB=Chevron Blue, PB=Pepsi Blue

Muscle Car Body Dimension Sheet

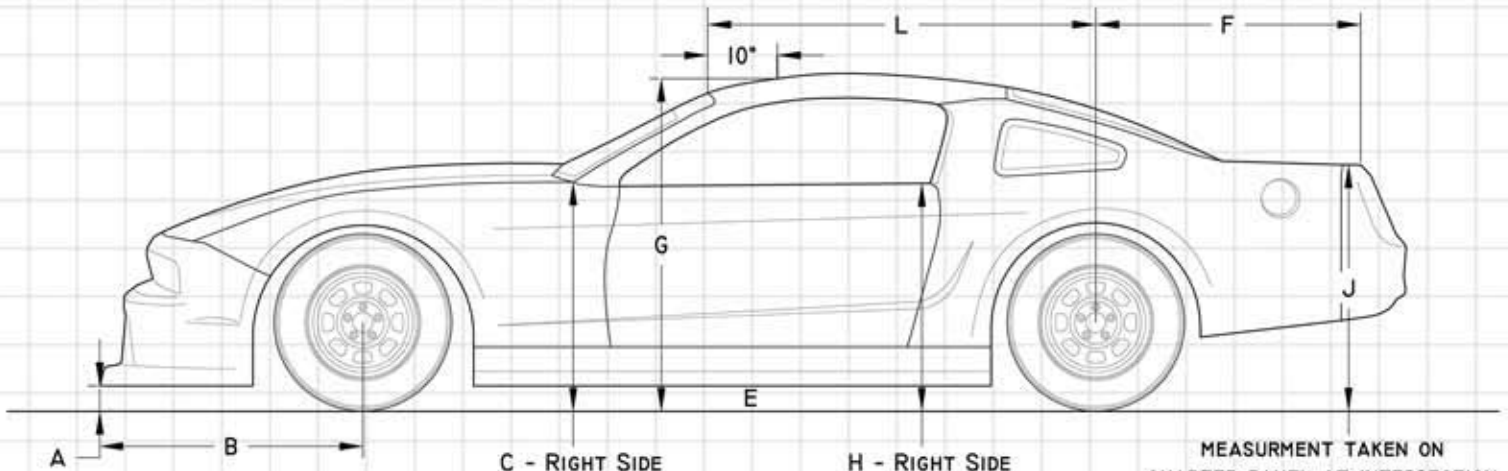
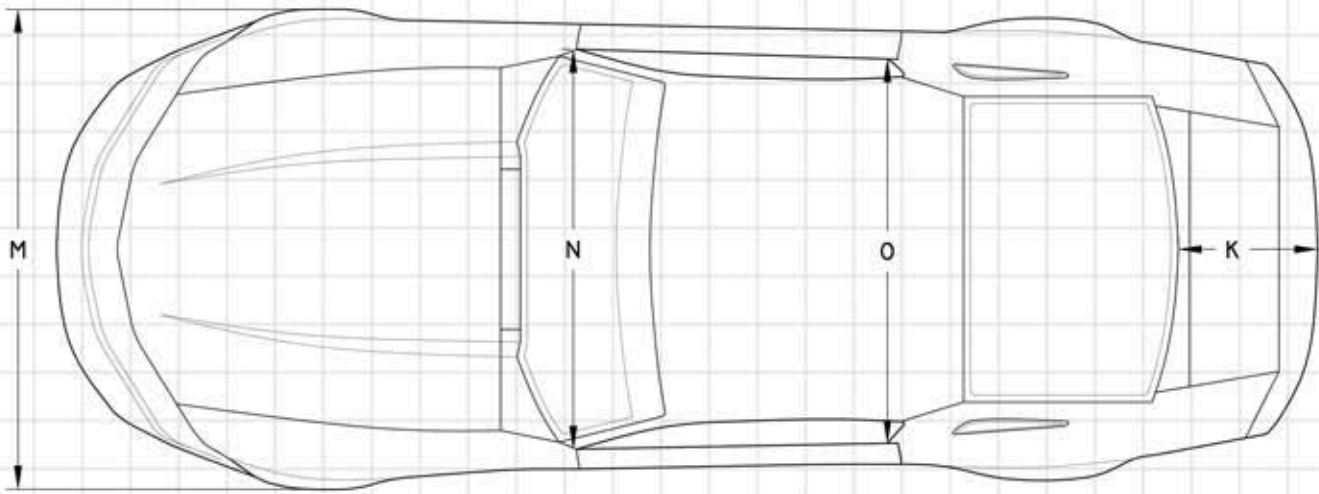

C - RIGHT SIDE
D - LEFT SIDE

H - RIGHT SIDE
I - LEFT SIDE

MEASUREMENT TAKEN ON
QUARTER PANEL AT INTERSECTION
OF DECKLID & BUMPER COVER

A.	NOSE HEIGHT (MIN): from ground to bottom of nose	4"
B.	FRONT OVERHANG (MAX): on centerline	46 3/4"
C.	FENDER HEIGHT: RIGHT at front of A-post from ground	32 3/4"
D.	FENDER HEIGHT: LEFT at front of A-post from ground	32 1/2"
E.	SIDE PANEL CLEARANCE (MIN): from ground	4"
F.	REAR OVERHANG (MAX): from base of spoiler at centerline to axle center	44 1/2"
G.	ROOF HEIGHT (MIN): 10" back from windshield, on centerline	48"
H.	DOOR HEIGHT: RIGHT at rear	33 1/4"

I.	DOOR HEIGHT: LEFT at rear	33"
J.	QUARTER PANEL HEIGHT: at bumper cover/decklid intersection	35 1/2"
K.	REAR DECK: at center, from base of spoiler to rear window	21 1/2"
L.	FRONT OF ROOF TO CENTER OF REAR AXLE:	56"
M.	BODY WIDTH: at wheel wells	80"
N.	DOOR TO DOOR WIDTH: FRONT at "A" post and inside edges of the doors	65 1/4"
O.	DOOR TO DOOR WIDTH: REAR at "B" post and inside edges of the doors	63 1/4"

Fender & Nose Braces

Steel Fender/Nose Brace

3/8" Steel 2pc slide together tubing braces. Designed to slide into a 1/2" telescoping tube with welded 1/4-20 threads. Durable Gloss Black Powder Coated Finish. Adjust to 28" and can be cut down to 8". Approx weight = 6 ounces

PN 50201 \$ 10.95 ea

Nicest Body Braces
Anywhere

Works Great to Brace & Adjust Nose Supports and Fenders

PN 50202 \$ 11.95ea

ALL NEW Durable Aluminum Fender/Nose Brace

Now with Heavy Duty replaceable ends!

Same as above except it is all aluminum for the best in weight savings. Approx 1/2 the weight of steel even when using replaceable steel ends. Silver Powder Coated Receiver Tube. Weighs less than 3 ounces.

Replaceable Aluminum & Steel Ends

Fits 3/8" round braces.
Predrilled for easy mounting.
Assembles with 3/16 rivets.
Die stamped radiused ends with 1/4" mounting holes.
Larger OD and thicker tubing wall for a stronger brace.
Easily make any length you need, just put on two ends.

less than 1/2 oz each



Aluminum Ends

PN 50212 - \$ 9.95 (pk of 4)

less than 1oz each



Powder Coated Steel Ends

PN 50211 - \$ 9.95 (pk of 4)

3/8" & 1/2" Flex a Brace

Black composite rod will easily flex to over 120 degrees without breaking. 3/8" Rod Comes standard with aluminum receiving tube with welded 1/4-20 nut for easy adjustments and scalloped mounting bracket. Adjust up to 28". Approx weight = 4.5 ounces.

3/8" - PN 50205 \$ 17.50ea

Works Great for
1/4 Panels & Rear Bumper
Cover Bracing

Flex a Brace

For More Strength try our 1/2" Flex a Brace

Great for Larger High Speed Tracks

1/2" - PN 50208 \$ 21.95ea

Adjust from both ends

.063 Aluminum Scalloped Mounting Bracket

PN 50204 \$ 6.95 (Pk of 4)



Bumper Bars, Pin Bars & Grill Screens

Muscle Car Front and Rear Bumper Bars

1-3/4" .065 wall mild steel round tubing preformed to fit the contour of the Nose and Tail

Camaro Rear - PN 11065 \$ 30.00
Mustang Rear - PN 20365 \$ 30.00

Camaro Front - PN 11055 \$ 30.00
Mustang Front - PN 20355 \$ 30.00

Muscle Car Hood and Tail Pin Bars

5/8" mild steel square tubing preformed to fit the contour of the Nose and Tail

Camaro Tail Pin Bar - PN 11067 \$ 18.50
Mustang Tail Pin Bar - PN 20367 \$ 18.50

*All RED tubing components painted to show detail
Actual parts are bare, unpainted steel*

Camaro Hood Pin Bar - PN 11058 \$ 19.50
Mustang Hood Pin Bar - PN 20358 \$ 19.50

Camaro Lower Grill Screen

Lightweight Aluminum bezel with stainless steel wire screen.

Camaro Grill Screen - PN 11091 \$ 46.50



Mustang Lower Grill Screen

Lightweight Aluminum bezel with stainless steel wire screen.

Mustang Grill Screen - PN 20391 \$ 46.50



Bumper Bar Installatin Kits & Sliders



Receiving Tube Installation Kit

Kit Includes Everything Pictured

- 2 - CNC cut 3/16" steel slotted brackets
- 2 - Threaded Bosses
- 4 - 1/2" Bolts
- 2 - Large OD Flat Washers
- 2 - Nylock Nuts
- 8 - rivets for part placement
- 1 - guide with instructions PN 50304 \$ 24.95

Front Bumper Receiver Tube

Complete with 1/4-20 Jam Hex Bolt and Through Bolt with washer and nylock nut

Universal design, one piece works for Left or Right sides

Slotted mounts allow 3" of nose height adjustment

Receiver tubes can flip for maximum adjustment

Designed for 1-1/2" round bumper tubes

Durable Black Powder Coat Finish



PN 50301 \$ 19.99 ea

Front and Rear Bumper Bar Installation Kits



- (2) 1-1/2" round 22" *prenotched tubes (front 30°, Rear 10°)
- (2) Weld on receivers with threaded boss and thru hole
- (2) Jam Bolts, (2) thru bolts with nyloc nuts
- *tubes are prenotched to fit 1-3/4" round bumper bars
- Front Bumper Installation Kit - PN 50306 \$ 19.95
- Rear Bumper Installation Kit - PN 50307 \$ 19.95

Adjustable Sliders

Makes for easy adjustment of hood or tail pin bars, rockers and other body panels

up to 2-3/4"

(2) 6" x 3/4" tubes fit over 5/8" square

(2) 3/8" bolts and flange nuts

PN 50305 \$ 7.95 (pkg of 2)



1 Align guide flush with front and top edge of fram rail



2 Clamp securely into place and drill all holes 3/16"



3 Remove guide, drill center hole out to 3/4"



4 Rivet threaded retainer and slotted bracket into place



5 Weld retainer and bracket securely before using



6 Bolt on reciever tube and install front bumper assembly

Valances, Valance Washers & Brake Ducts

Valance Wear Strips

Durable polyethylene wear strip allows you to keep your nose sucked down to the track. Mounts with either of our lightweight Valance Attachment Kits shown below. Available in 9 Racing Colors, (B-black, W-white, R-red, O-orange, PB-pepsi blue, CB-chevron blue, Y-yellow, NO-neon orange, NY-neon yellow)

Camaro - PN 402110x \$ 29.50 pair (x=color)
Mustang - PN 402203x \$ 29.50 pair (x=color)



**Now Available in
Neon Orange &
Neon Yellow**

**CNC Cut Valance
with adjustable slots**

Valance Attachment Kit 3/16" & 1/4"

Great Looking CNC machined from lightweight aluminum. 1 1/8" OD to keep your valance wear strip firmly where you want it. Enough CNC machined components to completely install your new Valance Wear Strip Kit. 80 piece kit includes CNC washers, flat head allen screws with nylocks and backup washers.

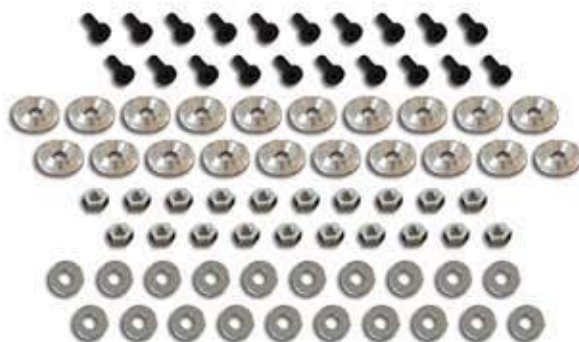

**Nicest Valance Kit
Available!**

lightweight 3/16" - PN 42305 \$ 49.50
1/4" - PN 40305 \$ 49.50



Valance Washer Repair Kit 3/16" & 1/4"

Want to spruce up your ride with a few new valance washers... we have just what you need. This 20 piece repair kit saves you money. Repair kit includes 5 CNC machined large OD valance washers, 5 flat head allen screws with nylocks and 5 backup washers.

lightweight 3/16" - PN 42405 \$ 14.50
1/4" - PN 40405 \$ 14.50

Offset Brake Ducts that Work ...ARBodies Exclusive!

With the New Narrower Noses most Brake Naca Ducts point your brake hose toward radiator duct work and ground. This causes problems running the brake duct hoses without kinking and blocking Air Flow. Not Good! These Specially designed Offset Brake Ducts fix these problems and work great with all ABC noses and most others as well. They help your hose run level and parallel to the front clip making it easier to run it without kinking. Thermoformed from Black HDPE for fit and durability. Made in Left and Right designs for better fit.



Single Left - PN 40505 \$ 22.50
Single Right - PN 40605 \$ 22.50

Dual Left - PN 40805 \$ 26.50
Dual Right - PN 40905 \$ 26.50



Smoother and Better Air Flow for Better Brakes!

Hood Pin Kits, Replacement Clips & Brackets

11 pc Complete Hood Pin Kit

Kit contains 55 pcs: 11 pins, 11 scuff plates, 11 torsion clips and 22 jam nuts, Everything you need for your hood and decklid installation, when using an AERO deck lid extrusion.

3/8" Aluminum Solid pin kit - PN 42000 \$ 59.50



Lightened Aluminum Scuff Plates

Replacement Hood Pin Kits, Aluminum & Steel

Each Pin comes with 2 jam nuts, scuff plate & your choice of Clip, all Steel Pins are Chrome plated.

	2 Pin Kit	4 Pin Kit	5 Pin Kit
3/8" Aluminum Solid Pin w/ Hair Pin	41062	41060	43100
3/8" Aluminum Solid Pin w/ Torsion	40062	40060	42100
Price:	\$12.95	\$22.95	\$28.95
3/8" Steel Solid Pin w/ Hair Pin	41662	41660	41665
3/8" Steel Solid Pin w/ Torsion	40662	40660	40665
Price:	\$11.95	\$20.95	\$25.95

Hair Pin Clip or Torsion Clip
Your Choice, Same Great Price!

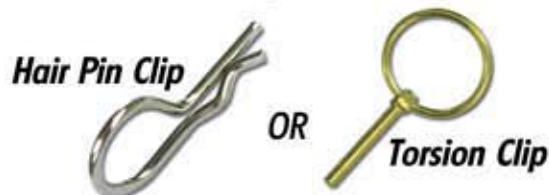

Lightweight Gundrilled Hood Pin Kits, Aluminum & Steel

Each Pin comes with 2 jam nuts, scuff plate & your choice of Clip, all Steel Pins are Chrome plated.

	2 Pin Kit	4 Pin Kit	5 Pin Kit
3/8" Aluminum Gundrilled w/ Hair Pin	41562	41560	41065
3/8" Aluminum Gundrilled w/ Torsion	40562	40560	40065
Price:	\$15.95	\$27.95	\$34.95
3/8" Steel Gundrilled w/ Hair Pin	41762	41760	41765
3/8" Steel Gundrilled w/ Torsion	40762	40760	40765
Price:	\$12.95	\$25.95	\$32.95

Quick Weight Saving Fact:
4- 3/8" Aluminum Gundrilled Hood Pins weigh Less than 1- 3/8" Steel Solid Hood Pin. A Great Value & Weight Saver!



Replacement Clips & Lanyards

Don't forget to keep spares in the pit cart!

Pkg of 5 Hair Pin Clips - PN 42260 \$ 6.95

Chrome Plated

21" lanyard

1 lanyard makes 2 pin hangers

Pkg of 5 Torsion Clips - PN 41160 \$ 6.95

Zinc Coated

Clip Lanyard
PN 43000 \$ 5.95 ea



*lanyard not included with clips

Cowl Pin Brackets

.100 aluminum brackets designed to fit prenotched areas on your Cowl Panel. Pre drilled rivet holes and hood pin hole for 3/8" pin, can be drilled for 1/2" pin. CNC stamped for durability.



Pkg of 4
PN 10084 \$ 19.95

ALL NEW DESIGN

Body Mounting Adjustable Braces

Powder Coated Black Adjustable 3/8" Hex Body Brace Kit

- Unique multi position mounting bracket allows several ways of attachment
- All rivet and bolt holes come predrilled in brackets
- Unique design allows access to rivet from front or back side
- Radiused bottom allows for better fit when attaching to bars
- Easily adjust with only one 3/8" wrench



Now with non gaulding CNC Steel Rod Ends

Lightest in the Industry

New Satin Black Powder Coated Finish

Stainless Clamps Sold Separately



Kit includes:

- 8 Rivets
- 4 Button head allen bolts
- 4 Plated nylocks
- 4 Low profile flat nuts
- 4 Stainless Steel button head bolts with lock washers
- 4 Custom made steel rod ends
- 2 Lightweight aluminum jam nuts
- 2 Hollow Hex tubes (7") with Powder Coat finish that adjust from 8" to over 10"
- 4 Multi Position Mounting Brackets

Best Value

Great Time Saver in Tech Line

4pk Stainless Clamps
PN 52000 \$ 5.95

These Hex Braces work Great to Support Body Panels, Window Braces and also make Lightweight Economical Rear Spoiler Braces

Bolt



Clamp



Rivet



New Radiused bottom fits roll bars

Powder Coated 3/8" Hex Body Brace Kit

PN 50100B \$ 31.50 (Pkg of 2)

ARbodies EZ Adjustable Body Braces Make Fitting Templates a Snap!



EZ to Install
EZ to Adjust
Lightest in the Industry!

New Design with Radiused bottom allows for better fit when attaching to bars



Create-a-Brace Kits

Polished Prethreaded 3/8" Hex Adjuster Tubes

- All tubes prethreaded 1/4-20 RH on one end and 1/4-20 LH on the other end
- Polished mirror finish, Lightweight hollow tubes easily adjust with 3/8" wrench
- 2 Prethreaded tubes per pack
- LH end marked with machined groove

3" Tubes - PN 50101-3 \$ 8.95 (Pkg of 2)

9" Tubes - PN 50101-9 \$ 9.95 (Pkg of 2)

5" Tubes - PN 50102-5 \$ 8.95 (Pkg of 2)

11" Tubes - PN 50102-11 \$ 9.95 (Pkg of 2)

7" Tubes - PN 50102-7 \$ 8.95 (Pkg of 2)



Adjustable Bracket Kit

- 2 LH & 2 RH lightweight steel threaded rod ends
- 4 lightweight multi position mount brackets
- 4 10-24 bolts and nylocks
- 2 RH aluminum jam nuts
- 2 hose clamps (roll bar mounting)
- 4 1/4-20 stainless steel button head bolts with lock washers and low profile flat nuts
- 8 1/8" Avex type rivets



PN 50101 \$ 17.50

Ready to Tap 3/8" Hex Tubing

PN 50102 \$ 17.00 (Pkg of 2 36" pieces, 6ft total)

- 3/8" Hex tubing custom extruded for ARbodies with ready to tap center ID, No Drilling required
- Aluminum Mill Finish
- Hollow tubes allow you to make any length bracket you need, up to 36" of adjustment
- Easily Taps 1/4-20 or 1/4-28

Stainless Clamp Kit

- Clamps allow you to easily attach Multi Position Brackets to roll bars
- Makes it EZ when positioning your roof, filler and cowl panels



2" Hose Clamps

PN 52000 \$ 5.95 (Pkg of 4)

Multi Position Brackets

- Custom designed, stamped .063 lightweight aluminum brackets
- Bolt, Clamp or Rivet on for easy adjustments



PN 50206 \$ 4.95 (Pkg of 4)

AERO Enhancing Products

Lightweight Roof Supports

Makes mounting and adjusting your roof easy, helps support the front and rear of your roof while keeping the proper shape for easy template fitting and best airflow and downforce.

Lightweight precision body mounting component, front weighs approx 11 ounces, rear weighs approx 9 ounces.

Muscle Car Front - PN 20351 \$ 29.95 ea

Muscle Car Rear - PN 20352 \$ 29.95 ea



Another ARbodies Exclusive!

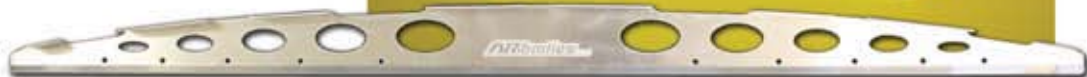

Trick Window Braces

CNC fabricated lightweight braces help keep your window supported with minimal weight. Designed to fit the contour of your window and help maintain shape and dowforce. Comes with foam stripping to keep from marring window. Aluminum mill finish extrusion, no ugly welding on these! Camaro & Mustang use same size for front window.

Powder Coated Black 3pc Front 24.5" - PN 701203 \$ 67.50

Powder Coated Black 4 pc Camaro Rear 28.5" - PN 711110 \$ 87.00

Powder Coated Black 4 pc Mustang Rear 34.25" - PN 711203 \$ 87.00



Speedway Window Brace Supports

7" Gundrylled hex rod window brace supports work great on high speed race tracks.

Each kit includes all mounting hardware.

1 complete support weighs approx 2 ounces.

3pc Front - PN 75300 \$ 39.50

2pc Rear - PN 75301 \$ 27.50



New Fender Supports

These supports are designed to stop air buffering of your front fenders behind the front wheels. These supports cover 25-35% more of your fender area than others available. Designed with 90 degree mounting flanges with predrilled holes for easy brace attachment. The left side fender support is specially designed to miss the foot box on most Super Late Models. Right side support has approx 35% more support and works great with our Right Side Body Brace. Manufactured from lightweight .050 aluminum.



Left Side - PN 50000L \$ 19.50 ea

Right Side - PN 50000R \$ 19.50 ea



AERO Enhancing Products

AERO Bracing... an Economical Alternative!

Unique extruded shape cuts through the air. Lightweight aluminum design. Each Kit contains 4 complete body braces. 4 30" pieces of AERO bar, 4 Scalloped Brackets and 4 Rivets. Simply cut to length, drill and rivet, no painting required!

PN 50199 \$ 19.50 (Pkg of 4)

Scalloped Ends swivel 180 degrees



This isn't Flat Bar!

Measures 30" x 1"



Aerodynamic Bullet Design
Less Drag!

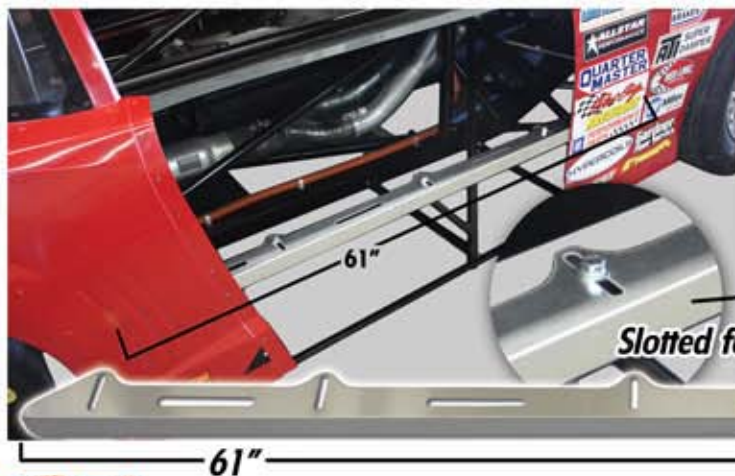

New Right Side Body Brace

Support your Quarter Panel, Door and Fender with our new extra long brace. Almost 2 feet longer than a standard door only brace. Added AERO support for entire Right side of the car. CNC manufactured from 6063-T6 Aircraft Grade Aluminum. Large 1-1/2" Flange to rivet to.

Slotted for EZ adjustment

PN 51000 \$ 39.50 ea

Right Side Body
Brace Installation Kit
(4 3/8" Weld Nuts,
Bolts & Flat Washers)
PN 51100 \$ 8.95

New Muscle Car Speedway Quarter Panel / Tail Supports

These supports are designed specifically for tracks where extreme high speeds are expected. These are the ultimate 1/4 panel & rear bumper cover supports to stop air buffering of your body panels behind the rear tires. These are manufactured from .050 aluminum and are CNC designed with double 90 degree mounting flanges to attach your braces. The front has a durable hemmed edge for added strength. These braces are also predrilled for EZ attachment of your body braces.

Measures 24" x 8"



Left Side - PN 50022L \$ 34.50 ea
Right Side - PN 50022R \$ 34.50 ea

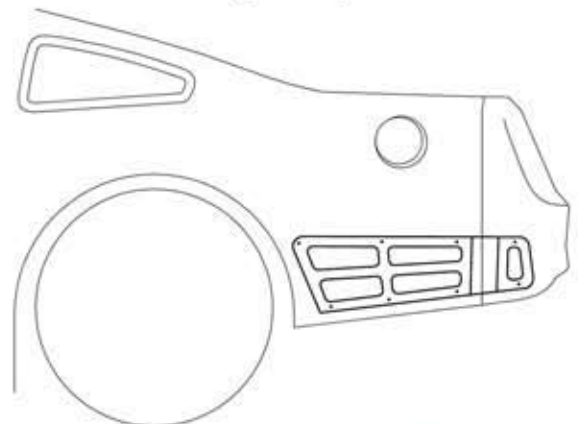

Cowl Air Induction Products

Pro Flow Cold Air Boxes

- Available in 2BBL. and 4BBL.
- Light Weight Composite Design
- Engine and Chassis Dyno Tested
- Better Distributor Clearance
- Choice of 14" or 16" Filter Size
(filter not included)

4BBL. 14" - PN 40414 \$ 269.50

4BBL. 16" - PN 40416 \$ 269.50

Replacement 1/2" Carb Ring - PN 40012 \$ 19.95

*also fits 2 barrel 4412 with no choke horn

Chassis Dyno Test Show up to 5 HP gain at Rear Wheels with 4BBL. Box!



Foam Insulation
in base to keep
air cooler!

Manufactured in Light Gray for Best Heat Reflection resulting in Cooler Air for your Carburetor

**Dyno Proven / Track Tested
Results Guaranteed...**

**Makes More HP at
Rear Wheels**

Chassis Dyno Test Show up to
7 HP gain at Rear Wheels with 2BBL. Box!



2BBL. 14" - PN 40214 \$ 269.50

These Boxes were designed for use with K&N and Wix Filters listed on page 27, others may not fit!

New Adjustable Cowl Air Induction Turn Down

WOW! Is this the best thing since sliced bread??? We think so!

ARbodies has another Industry 1st with our New Cowl Air Induction Turn Down. This is an EZ solution to what is normally a very hard, time consuming and tedious job. This turn down gets the cool cowl air into your cold air box efficiently without disruption of the air flow. This new lightweight aluminum, tig welded cowl turn down does a great job of that plus it can be installed in less than 1 hour. Manufactured from lightweight aluminum it is designed with a built in hinge system that allows for EZ adjustment from 3" to 4" filter heights. Works great on our 2004 to 2010 ABC Bodies and in many other applications as well.

Order Yours Today!

PN 10283A \$ 89.50

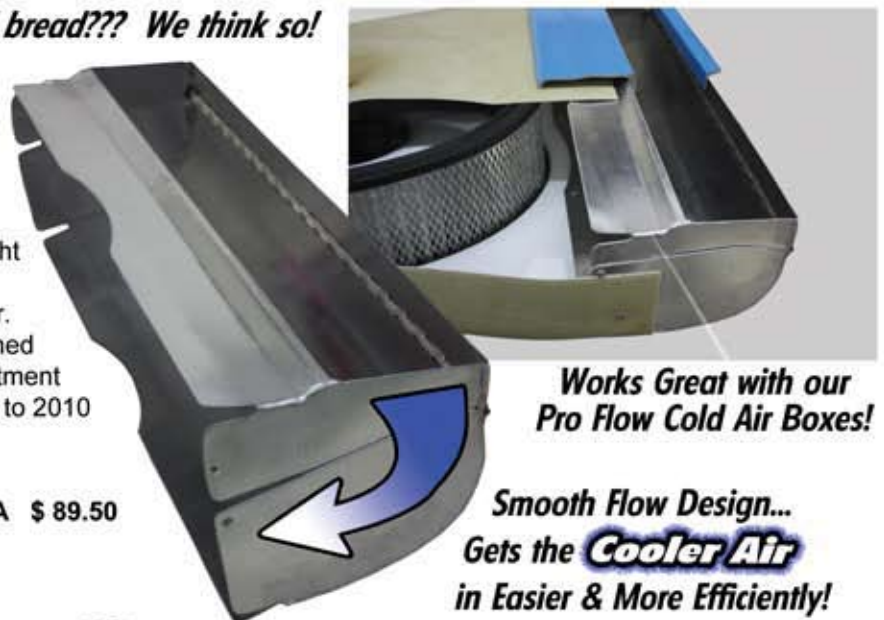

Garage & Pit Accessories

Racing Tape



- A. (2" x 90' Black Duct Tape) - PN 80000 \$ 8.95
- B. (2" x 90' Blue Duct Tape) - PN 80001 \$ 8.95
- C. (2" x 90' Orange Duct Tape) - PN 80002 \$ 8.95
- D. (2" x 90' Red Duct Tape) - PN 80003 \$ 8.95
- E. (2" x 90' White Duct Tape) - PN 80004 \$ 8.95
- F. (2" x 90' Yellow Duct Tape) - PN 80005 \$ 8.95
- G. (2" x 90' Black Dull Finish Gaffers Tape) - PN 80006 \$ 8.95
- H. (2" x 90' White Dull Finish Gaffers Tape) - PN 80007 \$ 8.95
- I. (2" x 90' Neon Green Dull Finish Gaffers Tape) - PN 80008 \$ 11.95
- J. (2" x 90' Neon Orange Dull Finish Gaffers Tape) - PN 80009 \$ 11.95
- K. (2" x 90' Neon Pink Dull Finish Gaffers Tape) - PN 80010 \$ 11.95
- L. (2" x 90' Neon Yellow Dull Finish Gaffers Tape) - PN 80011 \$ 11.95
- M. (1" x 180' Neon Orange Dull Finish/Gaffers Tape) - PN 80012 \$ 13.95
- N. (1" x 180' Neon Pink Dull Finish/Gaffers Tape) - PN 80013 \$ 13.95
- O. (1" x 180' Neon Yellow Dull Finish/Gaffers Tape) - PN 80014 \$ 13.95
- P. (4" x 10' Non-Skid Tape) - PN 80015 \$ 15.95
- Q. (2" x 180' Black Polyken Tape) - PN 80016 \$ 22.95
- R. (2" x 180' Metallic Polyken Tape) - PN 80017 \$ 22.95
- S. (2" x 45' Checkerboard Tape) - PN 80018 \$ 11.95

ARbodies Tire Tape

1/4" x 10' Tire Tape

PN 40000 \$ 4.95



Nylon Tie Straps

14" long



- Black - PN 54000 \$ 12.95 (Pkg of 100)
- Blue - PN 54001 \$ 12.95 (Pkg of 100)
- Orange - PN 54002 \$ 12.95 (Pkg of 100)
- Red - PN 54003 \$ 12.95 (Pkg of 100)
- Yellow - PN 54004 \$ 12.95 (Pkg of 100)

Air Filters

At Aluminum Racing Products we build Race Car Bodies and Components that perform on the track. We feel these are the best flowing Air Filters to use when using our Pro Flow Cold Air Boxes.

These Wix Filters feature Wire-backed gauze Reemay® media (T-66) which allows maximum air flow, while minimizing restriction to boost horsepower.



- WIX 14" OD Filters with a 12.25" min. ID
- (46945R) 3" tall - PN 45145 \$ 29.95
 - (46948R) 3.5" tall - PN 45141 \$ 29.95
 - (46944R) 4" tall - PN 45142 \$ 29.95

- WIX 16" OD Filters with a 13.75" min. ID
- (46974R) 3" tall - PN 45160 \$ 29.99
 - (46949R) 3.5" tall - PN 45161 \$ 29.99
 - (46940R) 4" tall - PN 45162 \$ 29.99

- *K&N 14" Filters
- (KNEASALMSKN3) 3" tall - PN 46140 \$ 49.99
 - (KNEASALMSKN35) 3.5" tall - PN 46140 \$ 49.99
 - (KNEASALMSKN4) 4" tall - PN 46142 \$ 49.99
- *(these K&N filters are all Sunoco Series Legal)

Rivets, Clecos, Washers & Drill Bits

Best Avex Type Multi Grip Rivets Anywhere

THESE RIVETS ARE GUARANTEED TO HOLD TIGHT & DRILL OUT EZ

Unique Design keeps stem deep in rivet for EZ Drill Out, These Rivets form their own Backup Washer when installed
Available in 3/16" Small Head 3/8" diameter, and Large Head 5/8" diameter

STANDARD LENGTH		GRIPS UP TO 6 PCS. OF .040 ALUMINUM	
Small Head 3/16"	250 pcs	Large Head 3/16"	250 pcs
COLOR			
Mill Finish	PN 6250 \$ 16.50	PN 6251 \$ 18.50	
White	PN 6250W \$ 17.50	PN 6251W \$ 19.50	
Black	PN 6250B \$ 17.50	PN 6251B \$ 19.50	
Red	PN 6250R \$ 17.50	PN 6251R \$ 19.50	
Chevron Blue	PN 6250CB \$ 17.50	PN 6251CB \$ 19.50	
Yellow	PN 6250Y \$ 17.50	PN 6251Y \$ 19.50	
Pepsi Blue	PN 6250PB \$ 17.50	PN 6251PB \$ 19.50	
Orange	PN 6250O \$ 17.50	PN 6251O \$ 19.50	

EXTRA LONG LENGTH		GRIPS UP TO 12 PCS. OF .040 ALUMINUM	
Small Head 3/16"	250 pcs	Large Head 3/16"	250 pcs
COLOR			
Mill Finish	PN 6252 \$ 19.50	PN 6253 \$ 21.50	
White	PN 6252W \$ 21.50	PN 6253W \$ 31.50	
Black	PN 6252B \$ 21.50	PN 6253B \$ 31.50	

3/16" Multi Grip Rivets



STANDARD

Most Popular for body mounting. Used where total amount of material being riveted does not exceed 1/4" Thick.

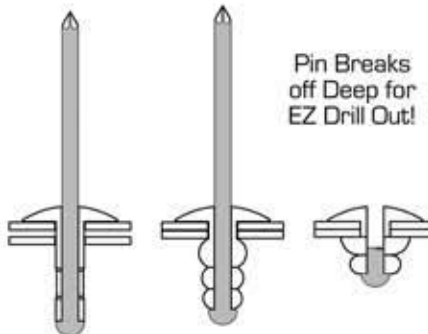

Pin Breaks off Deep for EZ Drill Out!



EXTRA LONG

Great for applications where total material thickness is from .080 to 1/2". Great for Composite, multiple layers or Thicker Plastic

3/16" Large Head Exploding Star Rivets

Works great on soft materials such as plastic to plastic or plastic to fiberglass.

100 ct. Mill Finished
PN 6104

\$ 19.50



1/8" Multi Grip Rivets 3/8" Diameter Large Head

250 ct. Mill Finished PN 5253 \$ 19.50
250 ct. White PN 5253W \$ 21.50
250 ct. Red PN 5253R \$ 21.50
250 ct. Black PN 5253B \$ 21.50



Backup Washers

	3/8" OD	5/8" OD
100 ct. 1/8" PN 5000	\$ 6.50	N/A
250 ct. 1/8" PN 5001	\$ 9.95	N/A
100 ct. 3/16" PN 6000	\$ 6.95	PN 6010 \$ 9.95
250 ct. 3/16" PN 6001	\$ 9.95	PN 6020 \$ 13.50



Body Installation Drill Bit Kit

3 Oversize Double ended drill bits for 3/16" Rivets
1 Oversize Double ended drill bit for 1/8" Rivets

PN 52400 \$ 12.95

Premium Body Installation Drill Bit Kit

Last Longer and drill easier... Single ended
4 Oversize drill bits for 3/16" Rivets
2 Oversize drill bits for 1/8" Rivets
Made In USA

PN 52401 \$ 15.95

Clecos 1/8" & 3/16"

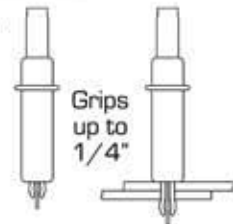

1/8" 20pk PN 53000 \$ 19.95
3/16" 20pk PN 53001 \$ 19.95

Cleco Pliers

Pliers - PN 53002 \$ 12.00

A Few of our Friends



Photo Credits: 51Sports/Speed51.com - Anna Denton Photography - Bryan Grangier - CG Photos
Doug Hornickel - Jamie Williams - Leif Tillotson - Mike Curran Photos/ontrackphoto.com - Photos By Odell - Race22.com - Ron Fox Photos - Tim Vinsant

Composite LMSC Bodies

**Straight Up Perimeter Style Composite
Late Model Stock Car Bodies**

105" - 108" Wheelbase

48" Roof Height



Philip Morris
7 Time Motor Mile Champion 2010 Martinsville 300 Winner
3 Time National Champion 3 Time Virginia State Champion

Plastic Fenders



Jamie Caudill
UARA All Time Race Winner

Call Today for a FREE LMSC Composite Bodies Catalog!

NGB Sportsman Bodies

Fits 62" Tread Width



**105" - 118" Wheelbase
51" Roof Height**

Take your current Sportsman from this...



Take that 80's Model to the 21st century!



Great Look & Superior Aerodynamics!

To This...



**as seen in
CIRCLE TRACK MAGAZINE**



This car has a 117" Wheelbase



Finally a True Sportsman Aftermarket Body designed to fit the taller, larger Sportsman style roll cages

Full Size Truck Reg & Ext Cab

Super Truck Bodies Available in Regular Cab and Extended Cab Chevy, Ford and Dodge Models Available

Full Size Fiberglass Truck Body Components

Change x to L (left) or x to R (right)

Body Panels Available in 7 Colors, Add color code to end of part number

Color Codes: W=White, B=Black, R=Red, Y=Yellow,
O=Orange, CB=Chevron Blue, PB=Peppal Blue

Desription	04 Chey	04 Ford	Dodge	Colors	Black	*Racer
Fender, composite	14000xx	24000xx	34000xx	155.00	142.50	119.50
Door, aluminum	14010xx	24010xx	34010xx	155.00	142.50	119.50
Quarter, Reg, composite	14020xx	24020xx	34020xx	194.50	169.50	149.50
Quarter Post, Reg, comp	14030xx	24030xx	34030xx	79.50	55.95	67.50
Roof, Reg Cab, composite	14050x	24050x	34050x	215.00	195.00	155.50
Quarter, Ext, composite	14020xx	24120xx	34120xx	194.50	169.50	149.50
Quarter Post, Ext, comp	14130xx	24130xx	34130xx	79.50	75.50	67.50
Roof, Ext Cab, composite	14150x	24150x	34150x	215.00	195.00	155.50
Hood, composite	14060x	24060x	34060x	289.00	199.32	167.50
A Post, composite	14029xx	24029xx	34029xx	54.50	49.50	42.50
Nose, plastic	14005xx	24005xx	34005xx	79.50	69.50	69.50
Tail, plastic	14015xx	24015xx	34015xx	79.50	69.50	69.50
Front Bumper Bar	14055	14055	34055			30.00
Rear Bumper Bar	14065	14065	14065			30.00
Hood Pin Bar	14057	24057	NA			24.50
Bed Cover Hinge	14094	14094	14094			14.50
Bed Cover Front	14095	14095	14095	51.50	49.50	44.50
Bed Cover Rear	14096	14096	14096	49.50	47.50	42.50
Ext Cover 18-3/4" x 16"	1401816	1401816	1401816	19.95	18.95	14.95
Ext Cover 18-3/4" x 21"	1401821	1401821	1401821	19.95	18.95	14.95
Reg Cover 30" x 16"	1403016	1403016	1403016	20.95	19.95	16.95
Reg Cover 30" x 21"	1403021	1403021	1403021	20.95	19.95	16.95
Spoiler 6 x 60 x 50	140665	140665	140665			59.50
Spoiler 6 x 60 x 70	140667	140667	140667			59.50
Upper Grill Screen	14090	24090	NA			46.50
Lower Grill Screen	14091	24091	NA			46.50
Headlights	140405	240105	340105			26.00
Taillights	140415	240415	340415			26.00
Upper Grill Decal	140406	240406	NA			14.50

* White Body Panels
All Truck Parts ordered in Colors are Special Order Only!

Complete Body Packages Starting at \$1595
Call for details

Full Size Truck Reg & Ext Cab



88 Monte Carlo

Aftermarket Fenders, Doors, Quarter Panel's and Rockers available, call for details!

22-1/2"



Made from Durable Plastic! Tough enough to take the punishment of short track racing!

88 Monte Carlo Nose

This nose was designed and built from an actual 1988 Cup Style Nose piece with an extra 2-1/4" added to the bottom to help keep the air from going under your car. For best Aerodynamics always seal your nose to the track or as close as possible. This nose is a must for the Serious Sportsman racer.

Nose & Tail Covers available in 7 Racing Colors, (B-black, W-white, R-red, O-orange, PB-pepsi blue, CB-chevron blue, Y-yellow)

88 Monte Carlo Upper & Lower Grill Screens

Upper and lower premade grill screen bezels with stainless screen. CNC manufactured to fit our 88 Monte Carlo nose piece featuring a light weight .032 aluminum preformed bezel (trim ring) with our durable welded stainless steel screen manufactured for maximum airflow to your radiator. Lower screen features CNC cut bowtie emblem and SS logo.

These grill screens look excellent and make the perfect finishing touch to your 88 Monte Carlo. Save many hours hard labor trying to hand make.

Right Side Nose Part# 17005Rx - \$58.75 (black,white) \$61.00 (colors)
Left Side Nose Part# 17005Lx - \$58.75 (black,white) \$61.00 (colors)



Upper Grill Screen Part# 17090 - \$44.50



Lower Grill Screen Part# 17091 - \$44.50

88 Monte Carlo Graphics

Realistic looking Headlight & Tail light Graphics make your car look like it actually has the original lights and makes a great finishing touch for your sportsman car. Sold individually or in a master pack that includes everything shown.

Upper Grill Decal Part# 170406 - \$14.50

Headlights Part# 170405 \$26.00

Taillights Part# 170415 - \$26.00



Nose ID Kit Part# 170421 \$30.95 (headlights+grill decal)

Master Decal Kit Part# 170420 - \$56.95 save \$\$, Includes all 3 kits

88 Monte Carlo Valance Wear Strips

3-1/2" tall valance made from durable .145 thick plastic, bolts to the lower valance area of your nose. CNC designed and manufactured with slots for easy adjustment. Makes it easy to adjust down to the track and keep that nose sealed off. Mounts using our Valance Attachment Kit, on page 14.

Available in 8 Racing Colors: B-black, W-white, R-red, O-orange, PB-pepsi blue, CB-chevron blue, Y-yellow, NO-neon orange

Part# 402170x (x=color) \$34.50 pair

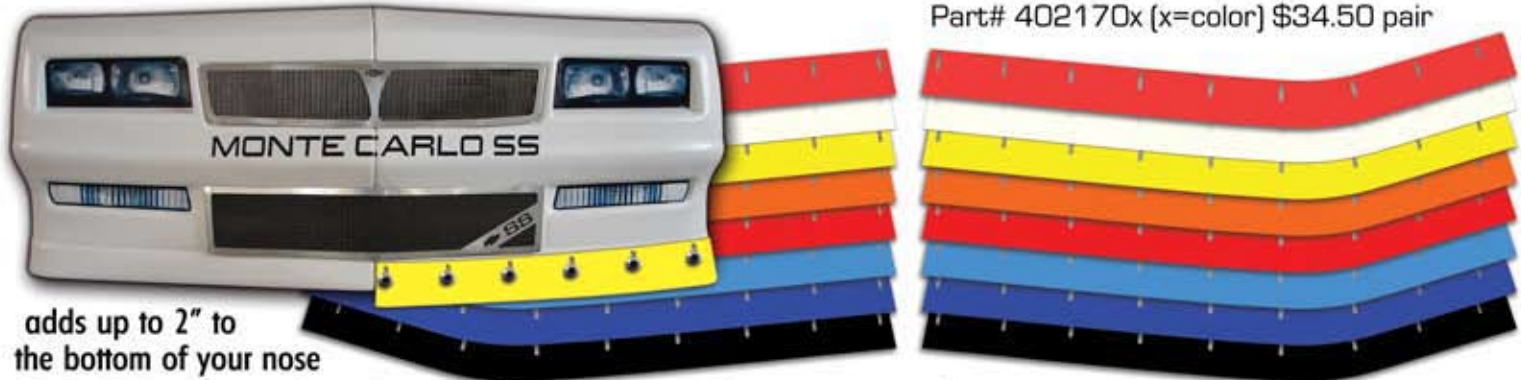

adds up to 2" to the bottom of your nose

88 Monte Carlo Tail, Rear Bumper Cover

Valance Attachment Kits, see pg 14

Another super durable product that will take a beating at your local short track. Same basic width and shape as a stock 88 Monte Carlo rear bumper cover. Saves weight when compared to stock parts.



Nose & Tail Covers available in 7 Racing Colors, (B-black, W-white, R-red, O-orange, PB-pepsi blue, CB-chevron blue, Y-yellow)

Right Side Tail Part#17015Rx - \$58.75

Left Side Tail Part#17015Lx - \$58.75

Spoiler Mount Kit Part#40615 - \$26.50

- 40 pc kit includes: 10 CNC aluminum countersunk wide OD washers, 10 backup washers, 10 nylocks and 10 countersunkbolts.

88 Monte Carlo Replacement Composite Hood

This hood has all the stock lines and shape plus it has been oversized by approx 1-1/2" on all sides to allow for fitting on the top edge of stock fenders or it can be trimmed to fit original stock dimensions

Hood Part# 17060 - \$166.75

Saves Weight and Looks Great! only 17lbs.

88 Monte Carlo Spoiler



2 pc. spoiler custom designed for 88 Monte Carlo's. Manufactured from durable 1/8" aluminum with CNC cut SS logo. 6" tall with mounting lip, total 60" wide, approx 55° Simply bolts to the back of our plastic rear bumper cover or to the original deck lid.

Spoiler Part# 170565 - \$69.50

86 Caprice



86 Caprice Nose

Designed directly from a 1986 Caprice Nose, with added lower valance to get the nose down closer to the track and seal it off. 2pc plastic design saves weight over the stock bumper components. Now everyone that runs a Caprice Sportsman car has a lightweight 2pc durable alternative similar to the 88 Monte Carlo yet designed specifically for a Caprice.

Nose & Tail Covers available in 7 Racing Colors, (B-black, W-white, R-red, O-orange, PB-pepsi blue, CB-chevron blue, Y-yellow)

Made from Durable Plastic! Tough enough to take the punishment of short track racing!

Aftermarket Fenders, Doors, Quarter Panel's and Rockers available, call for details!

Right Side Nose Part#17405Rx - \$58.75 (black,white) \$61.00 (colors)

Left Side Nose Part#17405Lx - \$58.75 (black,white) \$61.00 (colors)

86 Caprice Upper & Lower Grill Screens

Upper and lower premade grill screen bezels with stainless screen. CNC manufactured to fit our 86 Caprice nose piece featuring a light weight .032 aluminum preformed bezel (trim ring) with our durable welded stainless steel screen manufactured for maximum airflow to your radiator. Lower screen features CNC cut bowtie emblem and SS logo.

These grill screens look excellent and make the perfect finishing touch to your 86 Caprice. Save many hours hard labor trying to hand make.



Upper Grill Screen Part#17490 - \$44.50



Lower Grill Screen Part#17491 - \$44.50

86 Caprice Graphics

Realistic looking Headlight & Tail light Graphics make your car look like it actually has the original lights and makes a great finishing touch for your sportsman car.

Tail lights Part#174415 - \$26.00



Headlights Part#174405 - \$26.00

88 Monte Carlo/86 Caprice Front & Rear Bumper Bars

1-3/4" .065 wall mild steel round tubing preformed to fit the contour of the 88 Monte Carlo and 86 Caprice Nose and Tail.



Front - Part#17055 \$29.00

Rear - Part#10065 \$29.00

Front and Rear Bumper Bar Installation Kits

- (2) 1-1/2" round 22" *prenotched tubes (front 30°, Rear 10°)
 - (2) Weld on receivers with threaded boss and thru hole
 - (2) Jam Bolts, (2) thru bolts with nylocs
- *tubes are prenotched to fit 1-3/4" round bumper bars*

Front or Rear Bumper Installation Kit -

Part# 50307 \$19.95



86 Caprice Tail, Rear Bumper Cover

Another super durable product that will take a beating at your local short track. Same basic width and shape as a stock 86 Caprice rear bumper cover. Saves weight when compared to stock parts.



Nose & Tail Covers available in 7 Racing Colors, (B-black, W-white, R-red, O-orange, PB-pepsi blue, CB-chevron blue, Y-yellow)

Right Side Tail Part#17415Rx - \$58.75

Left Side Tail Part#17415Lx - \$58.75

Spoiler Mount Kit Part#40615 - \$26.50

- 40 pc kit includes: 10 CNC aluminum countersunk wide OD washers, 10 backup washers, 10 nylocks and 10 countersunkbolts.

86 Caprice Replacement Composite Hood

This hood has all the stock lines and shape plus it has been oversized by approx 1-1/2" on all sides to allow for fitting on the top edge of stock fenders or it can be trimmed to fit original stock dimensions

Hood Part# 17460 - \$166.75

Saves Weight and Looks Great! only 17lbs.

86 Caprice Spoiler



2 pc. spoiler custom designed for 86 Caprice Manufactured from durable 1/8" aluminum. 6" tall with mounting lip, total 60" wide, approx 55°. Simply bolts to the back of our plastic rear bumper cover or to the original deck lid.

Spoiler Part# 174565 - \$69.50

EZ-MAX Duct Work Systems

- ➔ 2 pc. molded durable plastic design easily adjusts left or right, in or out, and up or down for a sure fit.
- ➔ AERO Ribs, control and direct the air as it is distributed into the radiator.
- ➔ 1" Mounting flange helps create a positive seal to the radiator and nose piece
- ➔ Clear radiator inspection panel easily removes with quick release fasteners for easy cleaning. Fasteners and springs included.

Exclusively from ARbodies

EZ MAX Duct Work Systems

Now it's EZ to have Professional style Duct work right out of a box.

ABC EZ MAX Kits

Straight-up	PN40105	\$ 189.50
12° Layback	PN 41605	\$ 189.50



Improved Air Flow
=
Less Air Opening
=
More Downforce

- ➔ Works Great with ABC EZ Slide Front Bumper or ABC Preformed Front Bumper Bar
- ➔ Works Great with any approved ABC Body
- ➔ Track Record Breaking Duct Work

Arched Bottom Improves Air Flow Distribution

Unique 2 pc. Slide Together Design makes it simple

Designed for use on Straight-rail offset chassis



LMSC EZ MAX Kit
PN 41805 \$ 189.50



NGB EZ MAX Kit
PN 42105 \$ 189.50

EZ to install... EZ to Adjust... EZ to inspect... EZ to clean out

Ordering Information

TERMS AND CONDITIONS

DEALER DIRECT ORDERS: We encourage all customers to buy from our stocking dealers. If the dealer in your area knows the body style you are running, they will stock the parts you need. Ordering from your local dealer will SAVE you money on shipping charges.

Call today for the dealer nearest you

FACTORY ORDERS: ARbodies telephone hours are 8:00 am to 5:00 pm Central Time, Monday through Friday, evenings and weekends by chance. Most orders are shipped the same day they are placed.

SHIPPING: All orders are shipped FCA Aluminum Racing Products, Greenbrier, Tennessee freight collect. All orders must be pre-paid with credit card, cashier's check, money order, bank wire or certified check. Orders can be shipped COD/cash.

RETURNS: Unused parts may be returned provided the items are in new, undamaged condition (no dents, scrapes, holes drilled, rust, etc.). Returned items must be packaged with care and shipped freight pre-paid to Aluminum Racing Products, 2308 Industrial Dr, Greenbrier, TN 37073. A 20% re-stocking charge applies on all returns. No returns on special order items

RETURNED GOODS AUTHORIZATION:

1. A copy of the items to be returned must be received by Aluminum Racing Products for review before any items will be accepted.
2. Upon reviewing the item list, Aluminum Racing Products will provide a Returned Goods Authorization Number (RGA) for the items that will be accepted for credit consideration. Original Invoice must accompany all returns. No obsolete Parts.

WARRANTY: Due to the intended use of these products in racing, Aluminum Racing Products makes no statement of warranty or guarantee, written or oral, expressed or implied. Once the part is installed, the purchaser must assume all responsibility arising from malfunction, damage or misuse. No employee or officer of Aluminum Racing Products or its distributors has any authority to make statements contrary to these terms and conditions.

Prices are subject to change without notice.

No packing charge on truck shipments over \$250.00, not including freight.

All truck shipments less than \$250.00 will have a \$15.00 packaging and handling fee.

All returns must have an approved RA#

No returns after 90 days

Dealers: All drop shipments will incur a 5% per line item upcharge to cover all paper work.

Please inspect all items & note any damages on delivery receipt before accepting shipment. Freight carrier will not accept claims for damages not noted at time of delivery.

PAYMENT OPTIONS

PAYMENT BY CREDIT CARD:

Aluminum Racing Products accepts VISA, MasterCard, Discover and American Express. Your credit card will be billed for the full amount of the order upon request and will ship immediately.



PAYMENT BY COMPANY/PERSONAL CHECK, CASHIER'S CHECK/MONEY ORDER:

Aluminum Racing Products accepts Cashier's Checks and Money Orders for any US-based bank. Your order will ship immediately following our receipt of your payment. Orders prepaid with company or personal check will be held 10 days until check clears the bank.

UPS SHIPPING

Most component and accessory orders can be shipped via UPS. These items include (but not limited to) noses, bumper covers, aluminum & steel doors, spoilers, formed steel bumpers.

UPS GROUND: Shipments sent via UPS Ground will deliver before the end of the business day by a time pre-determined by your zip code. This varies from one to five business days. Please contact our Customer Service Department for actual UPS shipping time.

UPS NEXT DAY AIR: Shipments sent via UPS Next Day Air will deliver before the end of the next business day following shipment

UPS NEXT DAY AIR SATURDAY DELIVERY: Shipments sent via UPS Next Day Air Saturday Delivery will deliver by 3:00 pm (ET) Saturday.

UPS SECOND DAY: Shipments sent via UPS Second Day will deliver before the end of the the second business day following shipment.

UPS THREE DAY SELECT: Shipments sent via UPS Three Day Select will deliver before the end of the third business day following shipment.

TRUCK SHIPPING

Orders too large, too heavy or requiring shipment in three or more UPS boxes must be shipped via truck freight. These parts include (but are not limited to) complete bodies, hoods, roofs, quarter panels and some fenders.

All truck orders must be shipped to a commercial address. Residential deliveries will incur a \$45.00 surcharge. Residential address implies that there is a home on the property which is, therefore, not zoned as a business.

Truck shipping times vary with delivery location and carrier. Due to the expense of truck shipping, it is imperative that you plan accordingly when purchasing components for your car.

NOTE: Aluminum Racing Products uses actual shipping weight on all truck shipments which many times varies from actual component weight. Please contact our Customer Service Department for inquiries regarding truck shipments.

No Matter What You Race... We Got Your Body!



Super Truck Bodies



Extended & Reg Cab

2010 Fall Brawl Winner

Perimeter Composite Bodies



Martinsville 300 Winner

3 Time National Champion

Next Generation Sportsman Bodies



The Metric Alternative
105" to 118" Wheelbase

ABC Bodies



7 Time ACT Champion

Open Wheel Modified Bodies



Muscle Cars

